

SOLENOID VALVE(3/2 WAY)

3V100 SERIES



■ Specification

Model	3V110-M5	3V120-M5	3V110-06	3V120-06
Fluid	Air (to be filtered by 40 μ filter element)			
Acting	Internally piloted			
Port size	In=Out=M5		In=Out=1/8"	
Valve type	3 port 2 position			
Temperature	-5~60°C (23~140°F)			
Orifice size	5.5mm ² (Cv=0.31)		12mm ² (Cv=0.67)	
Lubrication	Not required			
Operating pressure	1.5~8.0 bar (0.15~0.8MPa)(21~114Psi)			
Proof pressure	12.0 bar (1.2MPa)(170Psi)			
Power consumption	AC: 2.5VA DC: 2.5W			
Protection	IP65 (DIN40050)			
Connection	DIN Terminal or Grommet			
Material of body	Aluminum alloy			
Max. frequency	5 cycle/sec			
Insulation	B class			
Voltage range	-15%~+10%			
Min. activate time	0.05 sec			

*Note: PT, NPT, BSPP Thread are available.

■ Symbol

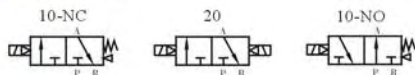

■ Ordering code

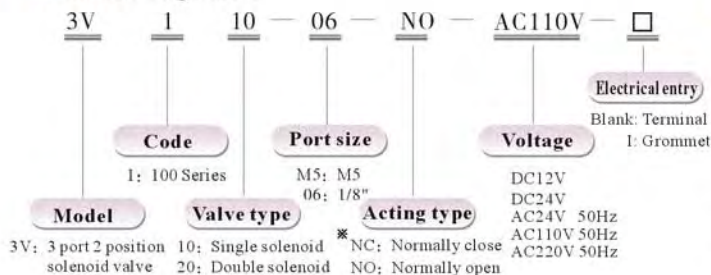

* Only single solenoid type has this specification.

■ Flow chart

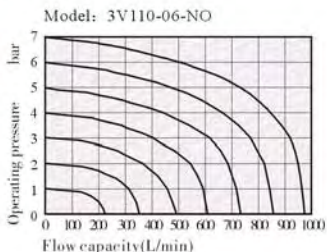

■ Inner structure

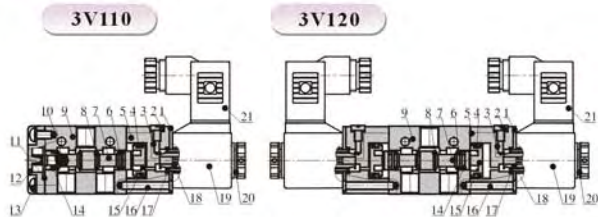

NO.	Item	NO.	Item	NO.	Item
1	Fixed plate	8	Spool O-ring	15	Piston
2	Manual override	9	Body	16	Pilot screw
3	Override spring	10	Spool spring	17	Armature O-ring
4	Piston O-ring	11	Bottom cover gasket	18	Armature
5	Pilot body	12	Bottom cover	19	Coil
6	Spool packing	13	Screw	20	Coil nut
7	Spool	14	Wearing ring	21	Connector

■ Material of major parts

Model	3V110	3V120
Body	Aluminum alloy	
Spool	Aluminum alloy	
Override O-ring	NBR	
Connector gasket	NBR	
Spool packing	HNBR	
Bottom cover gasket	NBR	-
Pilot O-ring	NBR	
Pilot body	Plastic	
Piston	POM	
Manual override	Iron	
Fixed plate	Steel with nickel plated	
Coil nut	Plastic	
Bottom cover	Zinc alloy	-
Override spring	Stainless steel	
Spool spring	Stainless steel	
Screw	Carbon steel	
Solenoid lining	Copper	
Armature	Pure iron	
Copper cover	Bronze	
Connector	Plastic	



SOLENOID VALVE(3/2 WAY)

3V100 SERIES

AIRTAC

■ Dimensions

3V110

Terminal

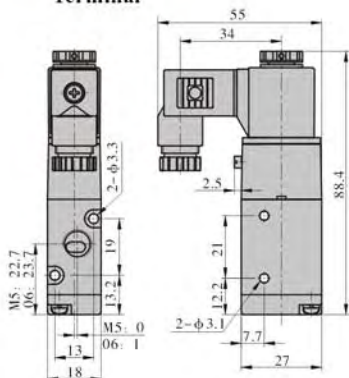

Grommet

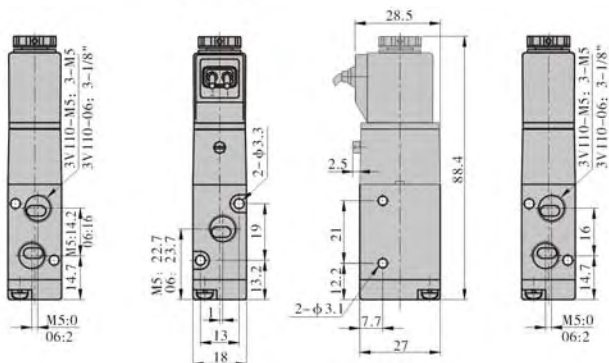

3V120

Terminal

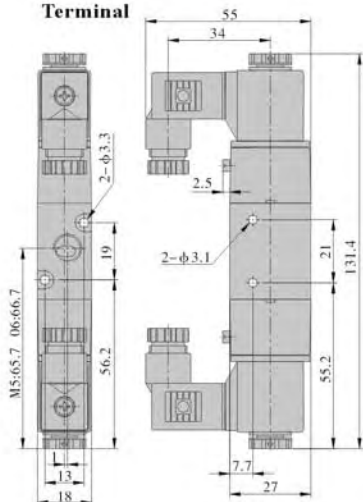

Grommet

